

Laser Imaging of Spray Systems

Image velocimetry and spray dynamics analysis

Mark Linne

University of Edinburgh



CECOST graduate school
October 23 - 27, 2017

Copyright ©2017 by Mark A. Linne.
This material is not to be sold, reproduced or distributed
without prior written permission of the owner, Mark A. Linne.



THE UNIVERSITY of EDINBURGH
School of Engineering

Topics

Importance of spray dynamics

Planar velocimetry

- ▶ PIV data acquisition and correlations
- ▶ Multi-dimensional PIV
- ▶ Warnings

Interface velocimetry

- ▶ Issues with interface images
- ▶ Velocimetry techniques



Spray dynamics

- ▶ According to Webster's Dictionary, a spray is "liquid broken up into minute droplets and blown, ejected into, or falling through the air" (or another gas).
- ▶ The material we wish to disperse into the gas is normally a condensed liquid stored in a container and then pumped out, so we need to go from a stream of continuous liquid into a collection of droplets.
- ▶ An injector converts continuous liquid into a collection of droplets, and it does that by adding energy somehow.
- ▶ In order to understand this energy scenario we should discuss the energy balance in a drop, and that has to do with interface energy.
- ▶ We know from thermodynamics that a system will achieve equilibrium if the Gibbs free energy is minimized. Here we are discussing thermodynamic quantities (i.e. pressure and temperature) and also mechanical properties like surface forces.



Spray dynamics

- ▶ The surface forces (surface tension) arise because inside a drop each molecule is surrounded by similar molecules and the binding forces (e.g. van der Waals) are uniform. At a surface, the liquid binding forces are directed toward the center, but they are not counter-balanced by the molecules on the other side of the interface.
- ▶ Binding forces acting between the molecules of same type are called cohesive forces (i.e. for the molecules in the center of a drop). Forces acting between molecules of different types are called adhesive forces (e.g. between the liquid and air). When adhesive forces are stronger than cohesive forces, the liquid acquires a concave interface and when adhesive forces are weaker the liquid acquires a convex interface (e.g. a drop).



Spray dynamics

- ▶ For an interface between a liquid and a gas, for example, we can write the change in Gibbs free energy as (based upon the Maxwell relations)¹:

$$dG = -SdT - V_{\text{liq}}dP_{\text{liq}} - V_{\text{gas}}dP_{\text{gas}} + \sigma dA + \sum_i \mu_i dn_i \quad (1)$$

where:

$G =$	Gibbs free energy,	$S =$	Entropy,
$T =$	temperature,	$V =$	volume,
$P =$	Pressure,	$\sigma =$	surface tension,
$A =$	surface area,	$n_i =$	number of moles of species i ,
$\mu_i =$	chemical potential of species i	$(\mu_i \equiv \partial G_i / \partial n_i)$	



¹see e.g. Physics and Chemistry of Interfaces: Third Edition, H.-G. Butt, K. Graff, M. Kappel, ISBN: 978-3-527-41216-7, Wiley, (2013)

Spray dynamics

- ▶ Equation 1 for constant T, P and n becomes:

$$\left(\frac{dG}{dA}\right)_{T,P,n} = \sigma \quad (2)$$

Equation 2 indicates that surface tension controls the equilibrium drop size, as you probably expected.

- ▶ For a fixed value of surface tension; to make smaller drops (negative dA) will require a similar negative dG .
- ▶ What this means is that in order to shrink the drop size we'd need the input of work (work-in is negative in the thermodynamic sign convention) to overcome the balance in equation 1. That work would be a form of energy that has not been included in equation 1.
- ▶ Where do we get the energy required to generate small drops?



Spray dynamics

- ▶ We can generate drops immediately from the liquid column as it leaves the injector (called “primary breakup”) and they then break up further as they flow downstream (called “secondary breakup”). Here we will discuss just primary breakup; the initial breaking of the liquid column to produce “primary drops”.
- ▶ In fact, we can define a dimensionless Weber number as:

$$We \equiv \frac{\rho V^2 \ell}{\sigma} \quad (3)$$

where ρ is the density of the liquid, V is the relevant velocity, and ℓ is a characteristic length (e.g. liquid column diameter for primary breakup).

Note that We is the ratio between kinetic energy acting to break up the column divided by surface tension energy holding it together.

High We indicates vigorous breakup.



Spray dynamics

- ▶ The required energy can come from turbulence:

◊ Wall-bounded turbulence inside the nozzle will suddenly be released as the flow exits into the gas. Eddies with large amounts of kinetic energy in the radial direction can provide the work required to overcome surface tension.

Unfortunately, the turbulence cascade means the flow does not have the kinetic energy at small scales (the dissipative scales) to produce very small drops.

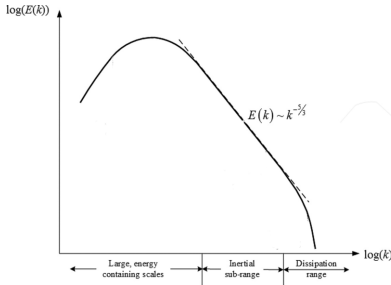

Spray dynamics

- ▶ The required energy can come from shear²:
 - ▷ Shear forces act at the interface between the liquid and gas.
 - ▷ In this image there is a central, laminar liquid core with a high-speed annular gas flow surrounding it.
 - ▷ Note the wave structures on the surface. The drop size will be on the order of the film thickness at the edge of each wave.

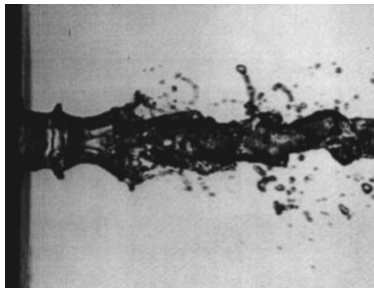

²“Liquid Jet Instability and Atomization in a Coaxial Gas Stream”, J. C. Lasheras and E. J. Hopfinger, Annu. Rev. Fluid Mech., 32:275308, (2000)



Spray dynamics

- ▶ The required energy can come from:
 - ▷ Turbulence plus shear can be a powerful combination.



- ▷ Even small amounts of swirl inside the injector can contribute to rapid radial expansion as the liquid leaves the nozzle, and that strongly enhances shear breakup.



Spray dynamics

- ▶ The required energy can come from bubbles:

▷ Bubbles in the flow (e.g. from cavitation) can suddenly collapse, sending powerful shock waves radially out from the center of the former bubble. At the edge they can have enough energy to break the surface.

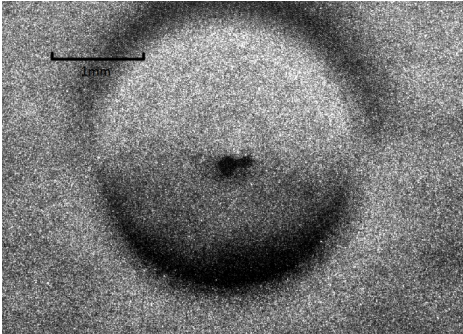

Shadowgram of a collapsing bubble, from Jiayi Zhou, Chalmers University



Spray dynamics

- ▶ There are spray systems that are designed to enhance some of these processes:
 - ▷ “Air-blast” atomizers rely upon shear between a gas and liquid, and so they require high air momentum to maximize shear.
 - ▷ “Effervescent sprays” create a bubbly flow inside the injector to take advantage of bubbles bursting.
 - ▷ “Simplex” atomizers create strong swirl in the flow, creating a conical spray. “Hollow cone” sprays do that without rotation just by the design on the outlet.
- ▶ So how do we capture the dynamics of such flows?



Planar velocimetry

- ▶ We rely upon image correlation techniques.
- ▶ Start with Particle image velocimetry (PIV) as a simple example.
 - ▷ The flow has to be seeded with oil droplets or particles.

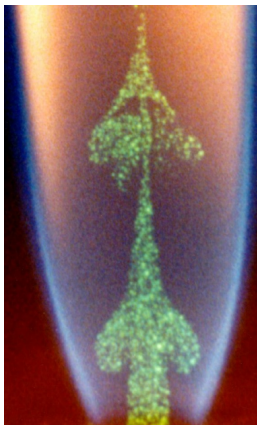

PIV

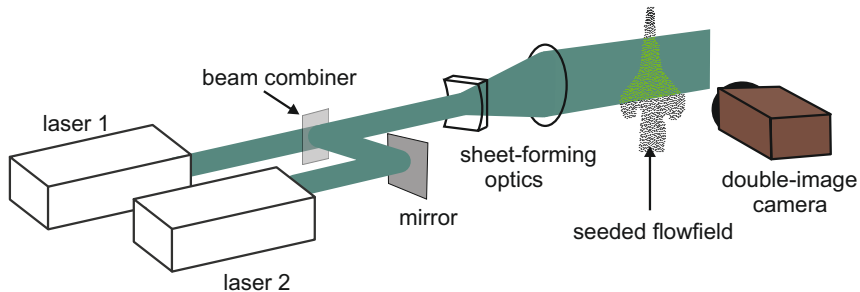

- ▷ An example PIV system, which relies upon two laser pulses.



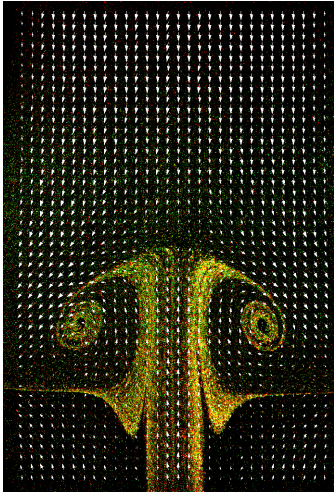

- ▶ To achieve good spatial resolution the flow must be densely seeded.
- ▶ One can't just follow individual particles between the two frames (that's called 'particle tracking velocometry') because the particle density makes it impossible.
- ▶ Instead, the image is divided into many small interrogation cells (typically around 1 mm square in the flow).
- ▶ The interrogation cell from frame 1 is correlated with the cell from frame 2.

PIV image processing

- ▶ Two interrogation cells from images taken with a known time separation Δt .
- ▶ A correlation between the two is found using FFT's.
 - ▷ The correlation theorem says that we can correlate two functions (here two different 2-D intensity distributions) by taking the Fourier transform of each, multiplying them, and then taking the inverse transform of the product.

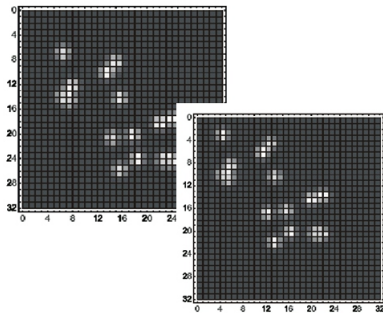

PIV image processing

- ▶ The correlation produces a cell-averaged offset Δl and velocity is then $\Delta l / \Delta t$.
- ▶ Notice the background noise in the correlation; the correlation peak has to rise above it or the vector is not legitimate (not 'validated').

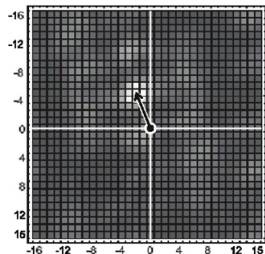

A correlation result.



PIV details

- ▶ There are actually a lot of details hiding inside the commercial PIV processing instrumentation. Most of the time it is fine to just use the instrument, but it is good to know what is going on.
- ▶ R. Adrian³ published a number of guidelines for high quality PIV. First, he said that the imaging system produces a spot image corresponding to every particle. If we assume the imaging system is diffraction limited, the particle image size d_i at the chip can be estimated by:

$d_i = (M^2 d_p^2 + d_s^2)^{1/2}$, where d_s is the diffraction-limited point response function of the lens given by

$$d_s = 2.44(1 + M)f/\#\lambda$$

here M is the magnification and $f/\#$ is the lens F-number defined by (lens focal length)/(diameter) (you set that with the camera aperture).

³ see e.g. "Particle Imaging Techniques for Experimental Fluid Mechanics", R.J. Adrian, Annu. Rev. Fluid Mech., 23, 261-304, (1991)



PIV details

- ▶ Real systems are not diffraction limited so the spot size will be bigger.
- ▶ That spot size estimate is controlled in part by diffraction. Diffraction limited spots are smaller if the diameter of the lens is larger, which is why $d_s \propto f/\#$ in the expression.
- ▶ Real lenses have aberrations (which are not included in the estimate) and if you use a small $f/\#$ (open the aperture a lot) you may suffer from them.
- ▶ The goal is to achieve the smallest spot size possible with the optical system so that the correlations are crisp.
- ▶ The estimate is useful, however, in terms of the magnification given by the setup you chose. Once you have a setup, you can just look at spot images in real time and adjust the lens to give the best image.
- ▶ Sometimes (e.g. tomographic PIV) it is more important to have a long depth of field, which means using a large $f/\#$.



PIV details

- ▶ The quality of the correlation peak (height of the peak compared to the sub-peaks caused by noise) determines the error in part, and if the system decides the ratio between the main peak and the next peak is too low it will discard the data (they will not be 'validated vectors' in the language of PIV).

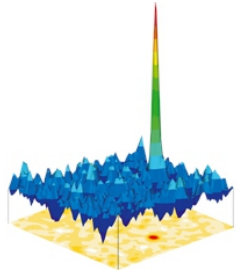

PIV details

- ▶ To get a decent quality correlation peak one needs to have over 15 particle pairs inside each interrogation cell. That need controls spatial resolution in the flowfield because if the seeding density is low, one has to use bigger interrogation cells.
- ▶ Relative particle displacement (controlled by the time delay between laser pulses Δt for a given flow) is also important. If the particles are too close then it will be hard to correlate them, and if Δt is too big then the second particle image will be over in an adjacent interrogation cell.
- ▶ The minimum in-plane displacement should be about twice d_i and the maximum displacement should be less than 1/4 of the interrogation cell size d_c , or:
$$\sqrt{u^2 + v^2} \Delta t < \frac{d_c}{4M} \text{ (just a "rule of thumb") .}$$
- ▶ Also, keep $d_i < 0.1d_c$.



PIV details

- ▶ For turbulent flow with 2-D PIV, the out-of-plane motion can be a problem; the second particle image could be lost because the particle left the laser plane. A good rule of thumb is to hold:

$$\frac{w\Delta t}{\Delta z_o} \leq 0.25$$

where w is the out of plane velocity and Δz_o is the laser sheet thickness. Adjusting the camera so that the depth of field matches or exceeds the sheet thickness (when possible) is a good idea.

- ▶ If there are velocity gradients (Δu) inside an interrogation cell the correlation peak can smear out, which lowers the height of the peak. Rules of thumb for that problem are:

$$\frac{\Delta u d_c}{u d_i} \leq 4 \text{ and } \frac{M \Delta u \Delta t}{d_i} \leq 1$$

- ▶ Do these things really matter?

If you start to get data you don't trust, start to think about these things.



PIV details

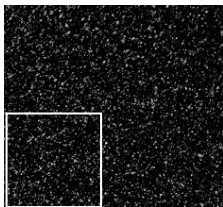

cell 1

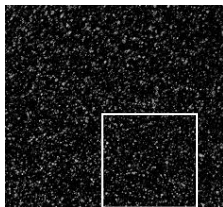

cell 2

- ▶ That is just an introduction to the kinds of issues people must concern themselves with, especially if they wish to study a challenging flow or extend the technique. Many other tricks are performed.
- ▶ For example, instead of this
Going to this



PIV details

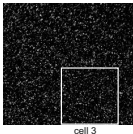
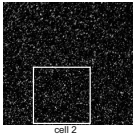
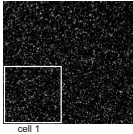

- ▶ Modern systems overlap interrogation cells (usually by a reported percentage)
Going to this
Going to this, and that gives some averaging for better noise while improving resolution.
- ▶ There are also tricks for locating correlation peaks at a sub-pixel level despite pixellation of the images.
- ▶ Most of this goes on in software without the user interacting.



PIV

- ▶ Why, then, did I say all of that?
- ▶ In the last 10 years some people seem to have started to think they can just point a camera and laser and then let the software sort it out, and there are times when it is obvious that their data can't be correct.
- ▶ Some people have even tried to extract velocities in dense regions with multiple scattering using their PIV systems.
- ▶ The features in such a flow are not point scatterers; the PIV correlations will not work properly but the software will automatically invent data anyway.

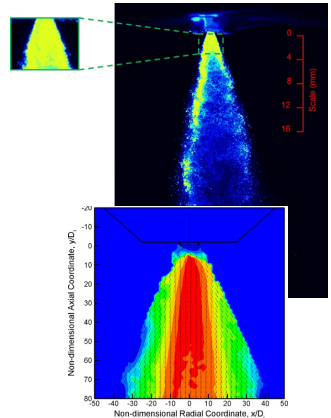

PIV

- ▶ There are some cases where one can use PIV in a spray:
 - ▷ One can look downstream in a more dilute region where multiple scattering is not a problem.
 - ▷ The drops have to be small enough that they will follow the gas flow (the same constraint applied to PIV particles).

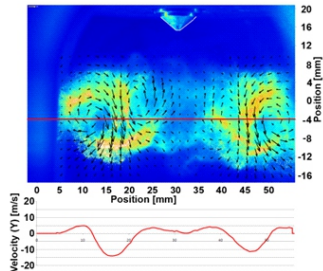

M. Andersson and J. Wärnberg, Paper ID ICLASS2009-189, 2009.



THE UNIVERSITY of EDINBURGH
School of Engineering

Stereoscopic PIV

- ▶ 'Stereoscopic' PIV uses two double-image cameras viewing the laser plane at an angle (with camera lenses in the 'Scheimpflug' arrangement).
- ▶ There is simply a geometrical transformation that maps a tilted object plane to an image plane.

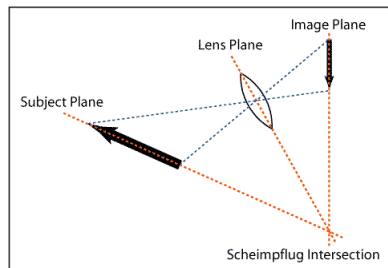

Stereoscopic PIV

- ▶ This allows one to extract an out-of-plane velocity component.
- ▶ The camera alignments have to be matched before starting because the out of plane motion will be extracted by geometrically comparing the interrogation cell vector from camera 1 to that of camera 2. This is done by placing a grid in the same location as the laser plane and then real-time image processing is used to match the 2 cameras up.
- ▶ Stereoscopic PIV then provides a 2-D image of 3-D velocity.

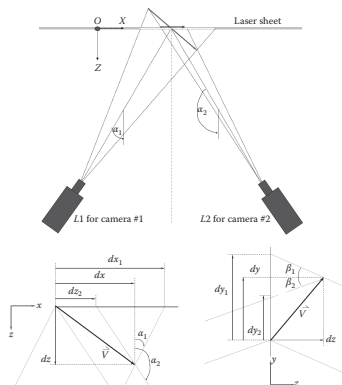

Stereoscopic PIV

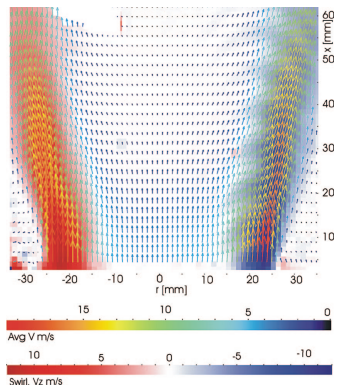

- ▶ One example from a low-swirl burner.
- ▶ The vectors indicate in-plane velocities and the colors indicate out of plane velocities.
- ▶ All the manufacturers sell this style with setup equipment and guidance, but it costs more.



Tomographic PIV⁴

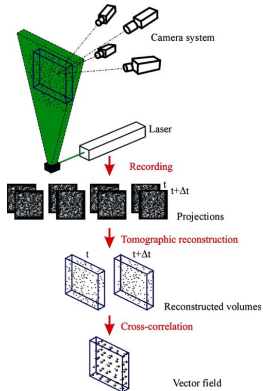

- ▶ Tomographic PIV is a serious extension of Stereoscopic PIV.
- ▶ More cameras are used and they are not located in a single plane. Their lenses are all in the Scheimpflug arrangement.
- ▶ The cameras have to be aligned similar to Stereoscopic PIV but more carefully.

⁴ Much of this discussion is based on “Tomographic particle image velocimetry”, G.E. Elsinga, F. Scarano, B. Wieneke and B.W. van Oudheusden, *Expt. Fluids*, 41, 933-947, (2006)



Tomographic PIV

- ▶ The laser sheet is expanded into a very thick plane of light and the camera lenses are stopped down to give long depth of field.
- ▶ The alignment grid now has to be scanned from one side to the other, doing camera alignment and calibration at many positions.
- ▶ A properly aligned system is used to capture 2 flow-field images per camera from different angles relative to the center plane of the laser sheet.

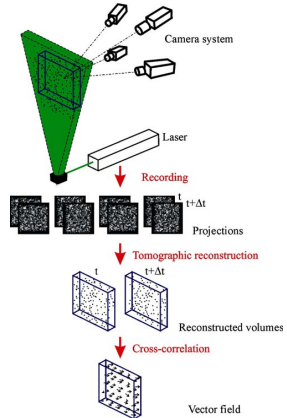

Tomographic PIV

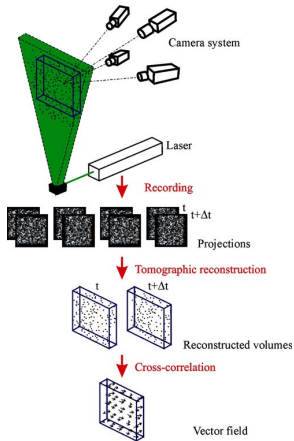

- ▶ A tomographic inversion is used to identify all the particle pairs in the volume.
- ▶ The particle pairs are then subjected to a 3-D correlation.
- ▶ A 3-D field of velocity vectors is extracted from the correlation.



Tomographic PIV

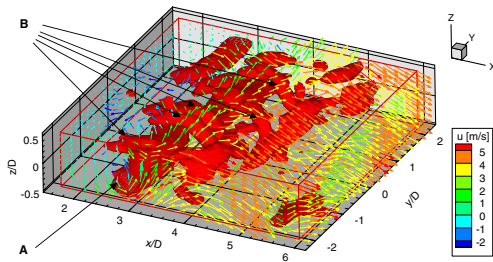

- ▶ Here is a nice result from Elsinga et al. The image shows every third vector, and the iso-surface is a vorticity magnitude ($|\omega| = 2.3 \times 10^3 s^{-1}$). 'A' labels a Karman vortex and 'B' labels secondary, streamwise vortex structures. This was a fairly slowly moving flow.



Tomographic PIV

- ▶ The tomographic inversion that works best for point images is an algebraic method (vs. Fourier or back-projection).
- ▶ There are additional issues to be considered, as detailed by Elsinga et al.
- ▶ The quality of the reconstruction goes up with the number of cameras, but for more than 5 cameras the benefits are not great.
- ▶ The cameras should be at an angle to the plane between 15° and 45° . Steeper angles do not sample enough of the volume but wider angles sample too much of it and the inversion starts to make too many “ghost” images.
- ▶ If 4 - 5 cameras are used one can load the flow with more particles for better spatial resolution. Otherwise they can cause too many ghost particles to be generated.
- ▶ Calibration errors should be held below 0.4 pixel (in location). There are ways to get to 0.1 pixel, so this is possible but takes care.
- ▶ The large depth of field and requirements of the inversion schemes produce spatial resolution that is not as good as 2-D PIV.



Tomographic PIV

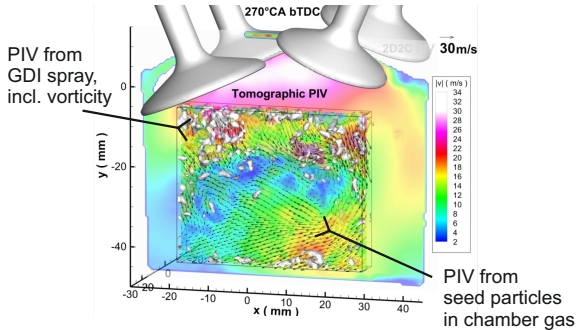

- ▶ Despite the difficulties, this technique has been applied to an optical IC engine at TU Darmstadt⁵. These results were checked against 2-D PIV and the agreement was excellent.

⁵ "On the turbulent flow in piston engines: coupling of statistical theory quantities and instantaneous turbulence" F. Zentgraf, E. Baum, B. Böhm, A. Dreizler, and B. Peterson, Physics of Fluids, Vol. 28, No. 4, 045108, (2016)



Interface velocimetry

- ▶ Can we also extract velocity from images like this one?

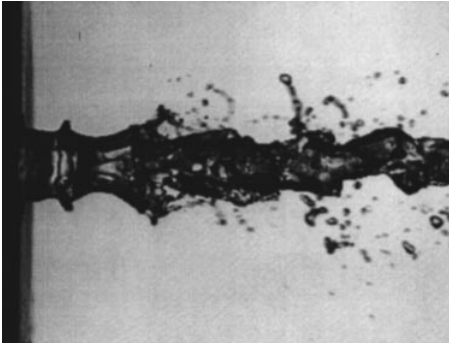

- ▷ If we get two such images separated by a time difference Δt , can we get the velocity?
- ▷ There are ways to get some velocity and acceleration information about the interfaces, but first some warnings.



Interface velocimetry

- ▶ Consider a PLIF image as an extreme example⁶.

- ▷ Unlike the sharp point images one obtains in PIV, this image has diffuse gradients. If we divide this image into small interrogation cells it will be impossible to do correlations.
- ▷ Also - how do we know a displacement of intensity from one frame to the next was caused by in-plane fluid motion and not out-of-plane motion, or by chemistry or diffusion?
- ▷ Do not try this!

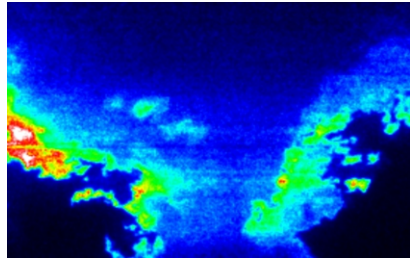

⁶"Systematic errors in optical-flow velocimetry for turbulent flows and flames", J. Fielding, M.B. Long, G. Fielding, and M. Komiyama, Applied Optics, 40:6, 757-764, (2001)



Interface velocimetry

- ▶ This kind of flow is missing much of the gradient problem, and it is not reacting or diffusing, which makes it possible to get data.

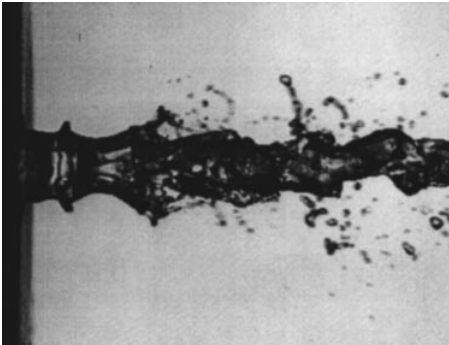

- ▷ If we have two images separated by a time difference Δt , there may be ways to extract velocity and acceleration.
- ▷ You already know what I said about using commercial PIV software.



Interface velocimetry

- ▶ But, to re-emphasize, it's not possible to just do correlations.
- ▶ Here, imagine the bulk fluid has not moved between two images. PIV correlation software will find a strong correlation between the parallel components (e.g. the horizontal spot) but it won't know which direction to point the vector. You'd get a forest of big vectors along the interface that have nothing to do with fluid movement.

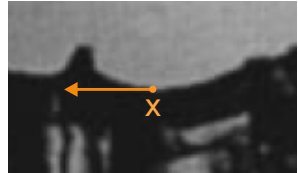

Interface velocimetry

- ▷ In a shadowgram, the light and dark spots inside the flow are caused by index gradients at the input and output faces.
- ▷ Imagine the jet didn't move but grew thicker. These light spots would change, and that would look like they moved.
- ▷ No interior structures from a shadowgram or Schlieren image should be correlated!
- ▷ Analyze just drops and fluid/gas interfaces.
- ▷ Even then, if an object does not move in the object plane, but does move closer to the camera, perspective will make it look bigger and then it will look like the interface moved. It's best to use the thinnest possible depth of field and reject results that are based on out of focus first or second images via binarization and edge detection.

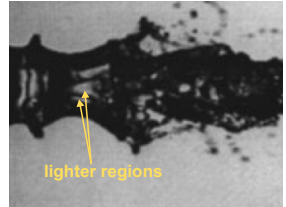

Interface velocimetry

- ▶ To extract velocity at the liquid/gas interface, one must be careful acquiring the original images to make sure that the two images are registered to each other correctly. The easiest way to do this is to use one camera with an interline transfer style chip (as all PIV systems use). These are capable of acquiring two images separated by as little as 1 microsecond. Otherwise, if it is necessary to use two cameras one can use commercial PIV systems to align them to a grid placed in the object plane.
- ▶ Images should be flat field corrected to give good edge definition. This is required because each pixel has a different level of dark current (the current generated even when no light is falling on the pixel) and a different amount of electrical gain for input photons (including the wavelength dependent quantum efficiency).



Interface velocimetry

- ▶ To do a flat field correction, one must record an image with the lens blocked for the dark current image and then acquire images with varying light intensity, but the intensity has to be uniform across the chip. One then creates a calibration formula for each pixel, zeroing the dark current levels and matching gain curves. Most scientific cameras have this as a built in feature.
- ▶ If you used an image intensifier you may also need to re-work the flat field correction before edge detection and binarization⁷.
- ▶ One should also acquire an image without the flowfield present so that one has an idea of the background. One can then use this image to do background subtraction on each jet image, to remove spatial variations caused just by the light source or other non-flow related artifacts.

⁷"Simultaneous correction of flat field and nonlinearity response of intensified charge-coupled devices", T.C. Williams and C.R. Shaddix, Review of Scientific Instruments 78, 123702 (2007)



Interface velocimetry

- ▶ It would then be best to binarize the image⁸, to remove the light and dark spots inside the image of the flow; to identify just the fluid/gas interfaces.

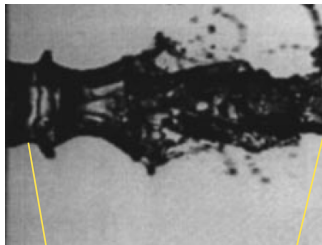

- ▷ To do edge detection and binarization, it's best to analyze the intensity distribution of the image and chose a cutoff point based on that, because human eyes are not good at seeing subtle differences (I didn't follow their directions here, sorry).

⁸"Minimum Error Thresholding", J. Kittler and J. Illingworth, Pattern Recognition, 19:1, 41-47, (1986)



Interface velocimetry

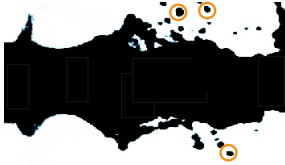

▷ Then for drops like those highlighted here one can use particle tracking velocimetry. In fact, one could use normal PIV software to get an estimated vector. One can use that estimated vector to locate the same drop in the second frame. Past that point, it would be best to find the weighted centroid of the two drop images (since these are not point images) and then get the displacement between the two centroids for improved accuracy.



Interface velocimetry

- ▶ There are several ways to extract velocity at distributed interfaces.
- ▶ "Optical Flow" uses this expression to describe the motion of the image irradiance I :

$$\frac{\partial I}{\partial t} + \vec{u} \cdot \nabla I = 0 \quad (4)$$

and by taking derivatives of the image one can extract the velocity of the image irradiance (\vec{u}) which can often be related to the flow velocity⁹.

- ▶ This approach falls into a category of solution called a gradient method.

⁹"Determining Optical Flow", B.K.P. Horn and B.G. Schunck, Artificial Intelligence, 17, 185-203, (1981))



Interface velocimetry

- ▶ To numerically search out a solution to equation 4 within constraints that control the method, Horn and Schunck propose a minimization over area A by varying u (in x and y):

$$\min_{u(x,t)} \int_A \left(\left[\frac{\partial I}{\partial t} + \vec{u} \cdot \nabla I \right]^2 + \alpha^2 \right) d^2x \quad (5)$$

where α is a constraint cost function (related to smoothness in their case).

- ▶ Gradient methods require taking derivatives of experimental (i.e. noisy) data. That will, unfortunately, introduce even more noise and so this approach can generate relatively high uncertainty.



Interface velocimetry

- ▶ One proposed way around that problem was presented by Tokumaru and Dimotakis¹⁰. They integrate equation 4 by use of a Taylor's series expansion in I . They couch the treatment in terms of a Lagrangian displacement field $\xi(\vec{x}, t)$ in which \vec{x} is a location on the field ξ to be tracked, and ξ represents a fluid element that can rotate and distort.
- ▶ If many terms in the Taylor expansion are retained, then many of the interfacial motions and distortions can be captured. One treatment could potentially be applied to the entire image. In practice, however, this requires too many terms. Instead the entire field is divided up into cells like the PIV correlation cells.
- ▶ Here we say that the displacement field $\xi(\vec{x}, t)$ transforms the field at \vec{x} at time t_0 to a new location at time t_1 , say.

¹⁰"Image correlation velocimetry", P.T. Tokumaru and Dimotakis, Expt. in Fluids, 19, 1-15, (1995)



Interface velocimetry

- ▶ We write:

$$\begin{aligned}I_o &\equiv I(x, t_o) \\ I_1 &\equiv I(x, t_1)\end{aligned}\tag{6}$$

and if we linearize I and integrate equation 4, we get:

$$I_1[\xi(\vec{x}, t_1)] - I_o[\xi(\vec{x}, t_o)] = 0\tag{7}$$

Which is much simpler. Similar to equation 5, we write:

$$\min_{\xi(\vec{x}, t_o), \xi(\vec{x}, t_1)} \int_A \left([I_1[\xi(\vec{x}, t_1)] - I_o[\xi(\vec{x}, t_o)]]^2 + \alpha^2 \right) d^2x\tag{8}$$



Interface velocimetry

- ▶ Equation 8 really applies only to simple translation, because we linearized the expression.
- ▶ If we divide the image up into sufficiently small cells, the motion within each cell can be taken as translation.
- ▶ Tokumaru and Dimotakis discuss methods for ensuring that each cell vector matches up to the next cell vector in a fluid mechanically correct sense, based on higher order terms, but this may not be necessary for images of simple liquid/gas interfaces.
- ▶ They then provide a scenario for solution of equation 8 in two dimensions, using matrix manipulations easily adapted in codes like Matlab.
- ▶ The main point is that even just extracting velocity from such images requires the researcher to stop using commercial PIV codes, do some serious background work, and write a code that properly interrogates the images.



Dynamics

- ▶ Measurement of velocity is a measurement of kinematics, not dynamics.
- ▶ If we have more than one measurement of velocity with a known time spacing (Δt) between each of them it is possible to estimate the acceleration involved simply by taking velocity differences and dividing by Δt .
- ▶ Often, but not always, the densities of the fluid and gas are unchanging and so an image of acceleration is an image of forces acting on the fluid, and that is a genuine image of dynamics.



Next topic

Imaging techniques based on ultra-short pulses.

