

Laser Imaging of Spray Systems

Imaging techniques based on ultra-short pulses

Mark Linne

University of Edinburgh



CECOST graduate school
October 23 - 27, 2017

Copyright ©2017 by Mark A. Linne.
This material is not to be sold, reproduced or distributed
without prior written permission of the owner, Mark A. Linne.



THE UNIVERSITY of EDINBURGH
School of Engineering

Topics

What's an ultra-short pulse?

- ▶ A bit of physical optics
- ▶ Short pulse lasers

Fundamental aspects of time-gated imaging

- ▶ Manipulation of polarization
- ▶ The optical Kerr effect

Ballistic imaging

- ▶ How it's done
- ▶ Examples, including velocity and acceleration



Topics - continued

Optical sectioning

- ▶ How it's done
- ▶ Examples

PIVOTS

- ▶ How it's done
- ▶ Examples



A bit of physical optics

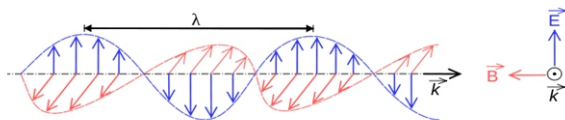

- ▶ Light is an electromagnetic wave (as are x-rays, microwaves etc.).
- ▶ The electric permittivity (ϵ_0) and the magnetic permeability (μ_0) allow the electric field (\vec{E}) to sustain the magnetic field (\vec{B}) and vice versa as light propagates through vacuum ('free space', the sub- \circ denotes free space).



A bit of physical optics

- ▶ The wavelength (λ , nm) and frequency (ν , 1/s or Hz) of light are related by $\nu = u/\lambda$, where u is the speed of light in a material. As an aside - spectroscopists often use wavenumbers, ν/c in cm^{-1} where c = speed of light in vacuum.
- ▶ $u = c/n$ where n = material index of refraction.
- ▶ ν is a constant ($\nu = u/\lambda = c/\lambda_0$ where λ_0 is the wavelength in vacuum); as light passes through various materials u and λ change with the index (n) of the material, but ν doesn't because energy ($E = h\nu$) is conserved.
- ▶ Light always has bandwidth, and frequency bandwidth can be written in terms of wavelength bandwidth as:

$$d\nu = - \left(\frac{c}{\lambda_0^2} \right) d\lambda_0 = - \left(\frac{c}{n\lambda^2} \right) d\lambda.$$



A bit of physical optics



- ▶ The connection between light and electromagnetic waves was discovered by James C. Maxwell. This statue of him and his dog sits at the end of George Street in Edinburgh.



A bit of physical optics

- ▶ If we make certain assumptions and apply vector calculus to Maxwell's equations, we get:

$$\nabla^2 \vec{E} = \mu_o \epsilon_o \frac{\partial^2 \vec{E}}{\partial t^2} \quad (9)$$

$$\nabla^2 \vec{B} = \mu_o \epsilon_o \frac{\partial^2 \vec{B}}{\partial t^2} \quad (10)$$

- ▶ Equations 9 and 10 are both wave equations, and the speed of the waves is given by $c = 1/\sqrt{\mu_o \epsilon_o}$.
- ▶ Independent measurements of μ_o , ϵ_o and the speed of light in vacuum (c) confirm this finding.



A bit of physical optics

- ▶ The following expressions:

$$\vec{E} = \text{Re} \left[\vec{E}_o e^{i(\vec{k} \cdot \vec{r} - \omega t)} \right], \quad \vec{B} = \text{Re} \left[\vec{B}_o e^{i(\vec{k} \cdot \vec{r} - \omega t)} \right] \quad (11)$$

are solutions to the wave equation, with $|\vec{k}| = 2\pi/\lambda$ and $\omega = 2\pi\nu$ (rad/sec). They describe the propagation of a simple plane wave (see next slide).

- ▶ The wave equation is linear, so equation 11 can form a basis set of solutions (with various values for \vec{E}_o , \vec{k} , and ω for example) that are combined to form more complex solutions to the wave equation.
- ▶ The plane wave solution (equation 11) is thus much more important than it may seem at first; it is the building block for physical optics solutions.



A bit of physical optics

- ▶ The three vectors \vec{E} , \vec{B} and \vec{k} form a right-handed coordinate system:
 - ▷ With vector calculus one can show that \vec{E} and \vec{B} are normal to each other.
 - ▷ \vec{E} and \vec{B} are both normal to \vec{k} , and \vec{k} points in the direction of plane wave propagation; so \vec{E} and \vec{B} oscillate transverse to the direction of propagation.

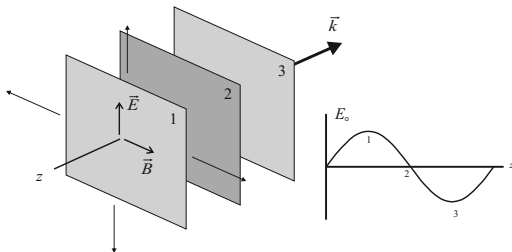

- ▶ Most optical interactions are electronic, so we often ignore the magnetic components of the expressions.



What's an ultra-short pulse?

- ▶ There is a Fourier transform relationship between bandwidth and time for light; the “time-bandwidth product” is a constant that is minimized at the transform limit. The time-bandwidth product for Gaussian-shaped, transform-limited pulses is 0.44.
- ▶ Most lasers have a sequence of longitudinal modes spaced apart in frequency by $\Delta\nu_{\text{modes}} = c/2L$, where L is the length of the laser cavity.
- ▶ In “mode-locking”, all of the longitudinal modes are locked to each other and so the spectral output of the laser is very stable.

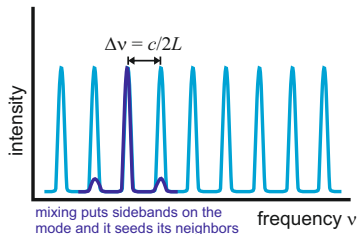

Short pulse lasers

- ▶ An infinite series of spikes in frequency can be Fourier transformed to give an infinite series of spikes in time.

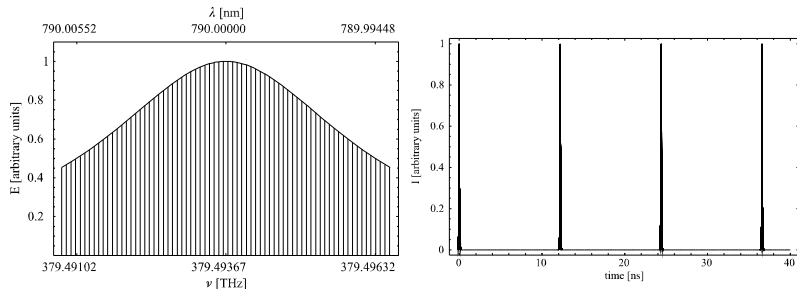

- ▶ This produces extremely quiet and stable laser output amplitude.



Short pulse lasers

- ▶ Think of each pulse as a summation of a Fourier series across many frequencies to give a very short pulsewidth.
- ▶ A transform limited pulse has all of the colors piled uniformly into the pulse waveform.
- ▶ The pulse rate is normally 80 - 100 MHz (the $c/2L$ frequency) and the average power is usually about 5 W, meaning the pulse energy is in nJ.

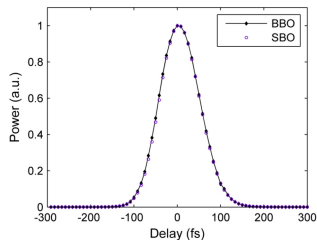

Short pulse lasers

- ▶ What if you want more energy per pulse (e.g. for a nonlinear process)?
- ▶ It is possible to convert the 5 W of average power into much more pulse energy if we slow the pulse rate down.
- ▶ A 1 kHz system can then generate 4 – 5 mJ/pulse which is a lot (TW at the peak of a 10 fs pulse).
- ▶ That much power at the peak would drill holes in the Ti:sapphire, so it is necessary to use “chirped pulse regenerative amplification”.



Fundamental aspects of time-gated imaging

Manipulation of polarization

- ▶ In equation 11, the amplitude terms \vec{E}_o and \vec{B}_o are actually vectors; they represent polarization. In optics, 'polarization' denotes the electric terms since optical interactions are nearly always electronic.
- ▶ Because the \vec{E} field oscillates normal to \vec{k} , it can potentially oscillate at any angle within the plane wave (so long as \vec{B} follows around and stays normal to \vec{E}).
- ▶ This means that any polarization state can be decomposed into two states.



Fundamental aspects of time-gated imaging

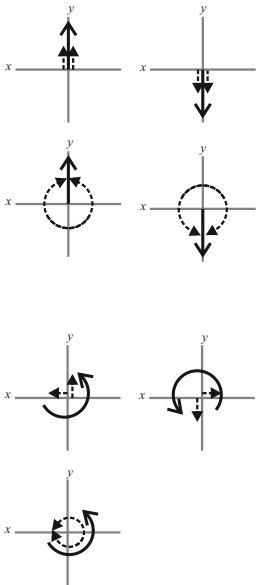

- ▶ Linear polarization (solid vectors) decomposed into two polarization states (dotted vectors).
- ▶ Circular polarization (solid vectors) decomposed into two polarization states (dotted vectors).



Fundamental aspects of time-gated imaging

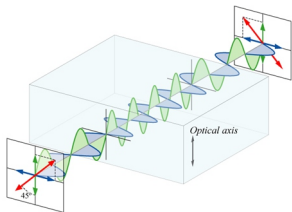
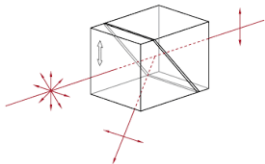

- ▶ Optical devices can be used to manipulate polarization. For example, a simple polarizer separates mixed polarization into two linear components.
- ▶ A birefringent material has a different index of refraction along the optical axis than it does normal to the optical axis.



Fundamental aspects of time-gated imaging

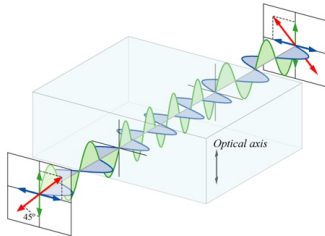

- ▶ In the image, linearly polarized light (red) enters the birefringent material. We decompose it into two waves - parallel (green) and perpendicular (blue) to the optical axis. The parallel wave propagates slower than the perpendicular one because the indices are different. At the exit, the parallel wave is delayed by half a wavelength (in this "half wave plate"), and the resulting combination (red) has been rotated 90° .



Fundamental aspects of time-gated imaging

- ▶ Time gating is used for some ultra-short pulse imaging techniques, and it relies upon manipulation of polarization.
- ▶ One way to switch light is to switch birefringence of a material on an off (inside a Q-switched laser cavity we often use a pockels cell).
- ▶ In 1875, Kerr discovered that isotropic, transparent substances can become birefringent when placed in an electric field.
- ▶ When voltage is placed across an electro-optic crystal it makes the crystal birefringent, which rotates polarization. Most pockels cells can flip polarization in nanoseconds.

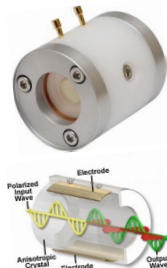

Fundamental aspects of time-gated imaging

- ▶ In 1956, Buckingham, a graduate student in London, theorized that the electric field created by an intense, linearly polarized light pulse would be sufficient to generate the Kerr effect.
- ▶ An optical Kerr effect (OKE) optical gate looks like a pockels cell but it is switched by the intense electric field of a very short optical pulse.
- ▶ The OKE active medium can be a liquid or transparent solid, but CS_2 has the best Kerr-optic coefficient and is most often used.

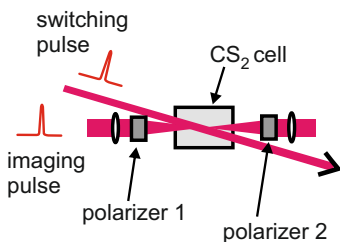

Fundamental aspects of time-gated imaging

- ▶ Before the switching pulse arrives, the cell filled with CS_2 is like a passive optical component (almost like a simple block of glass).
- ▶ Without the switching pulse the OKE gate is closed. Polarizer 1 is oriented to pass the polarization of the incoming imaging pulse, but polarizer 2 is oriented to block it.
- ▶ Polarizers can give 10^5 rejection ratios, so the gate really is shut off.

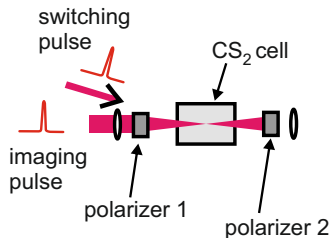

Fundamental aspects of time-gated imaging

- ▶ When the switching pulse arrives, the electric field impulsively orients the CS₂ dipoles and renders the cell birefringent. It rotates the imaging pulse polarization just enough to allow it to pass through polarizer 2.
- ▶ The switching pulse leaves immediately, and the CS₂ relaxes back to its formerly amorphous state via diffusion. The characteristic relaxation time for CS₂ is 1.5 ps.
- ▶ The Kerr gate is open for 1.5 ps, by design, and it passes 75% of the image light when it is open.

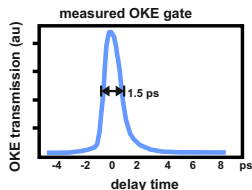
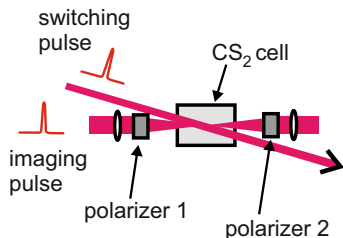

Fundamental aspects of time-gated imaging

- ▶ The Kerr gate works by inducing birefringence in the CS_2 .
- ▶ It is possible to induce birefringence several ways. There is a purely electronic process that is very fast. Solid state OKE gates are known to switch in several hundred fs using this process. Unfortunately, the transmission of the gate is only about 25%, which is quite low for spray imaging.
- ▶ The other main process is by molecular reorientations, which is what dominates in liquids like CS_2 .
- ▶ The optical Kerr effect is a nonlinear optical process, and we write the index of the material as: $n = n_o + n_2 I$ where n_o would be the normal linear index and n_2 is the nonlinear contribution that is “excited” by light with irradiance I .



Fundamental aspects of time-gated imaging

- ▶ For the case of molecular reorientation, and if we assume a Gaussian pulse shape, we can write the change in index as¹¹:

$$\Delta n = n_2 E_o^2 \frac{\tau_L}{\tau_o} \sqrt{\pi} \operatorname{erf} \left[\sqrt{2} \left(\frac{t}{\tau_L} - \frac{\tau_L}{2\tau_o} \right) \right] \exp \left[- \left(\frac{\tau_L}{2\tau_o} - \frac{\tau_L^2}{4\tau_o^2} \right) \right] \quad (12)$$

where:

- ▶ n_2 = molecular re-orientation index change (a known property of the medium),
- ▶ E_o = the envelope of the electric field, in terms of pulse shape and amplitude (in e.g. statvolts/cm),
- ▶ τ_L = the laser pulsewidth, and
- ▶ τ_o = molecular re-orientation time (a known property of the medium).

¹¹ "Time-gated Ballistic Imaging Through Scattering Media With Applications to Liquid Spray Combustion", M. Paciaroni. PhD Thesis, Colorado School of Mines, (2003).



Fundamental aspects of time-gated imaging

- ▶ The change in index in equation 12 happens along the polarization orientation of the switching pulse. The component of the imaging pulse along that same direction will experience a phase shift $\Delta\phi$ given by:

$$\Delta\phi = \frac{2\pi}{\lambda} L \Delta n \quad (13)$$

where L is the length of the Kerr active medium.

- ▶ One typically orients the polarization of the imaging beam at 45° to the polarization of the switching beam, so that the component of the imaging beam that is delayed is half the total irradiance.



Fundamental aspects of time-gated imaging

- ▶ If the Kerr cell is located in between a pair of crossed polarizers, the transmitted intensity will be:

$$I = I_o \sin^2 \left(\frac{\Delta\phi}{2} \right) \sin^2(2\theta) \quad (14)$$

where θ is the angle between the switching and imaging beams.

- ▶ Here is a comparison between a measured OKE gate transmission profile and the one predicted by equations 12, 13 and 14.

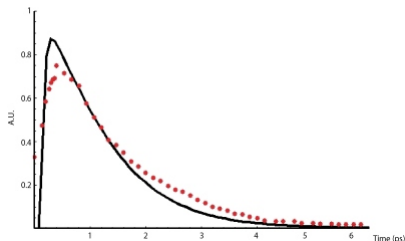

Fundamental aspects of time-gated imaging

- ▶ One typically uses equations 12, 13 and 14 to design the cell (e.g. length L , overlap angle θ given the available windows and ability to reject forward scattered switching light etc.) using known laser properties. During experiments, one then adjusts the energy of the switching pulse to optimize the switch.
- ▶ Practical issues include:
 - ▷ rejecting forward scattered light from the switching beam,
 - ▷ getting the timing right between the two pulses,
 - ▷ minimizing image corruption by the OKE gate.

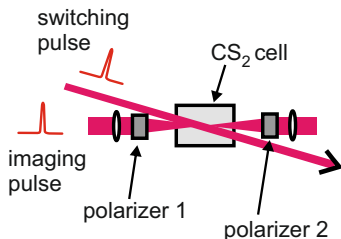

Ballistic imaging

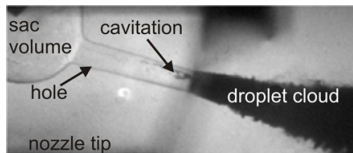

- ▶ Here¹² one can see a transparent Diesel injector nozzle tip with string cavitation that forms at the needle and grows as it progresses out to the end of the hole.
- ▶ Despite the paper title, it becomes impossible to see how the liquid column breaks up, once the liquid leaves the injector, because the droplet cloud is so dense.
- ▶ This is a known problem for specific kinds of sprays and Ballistic Imaging was developed to address it.

¹² "Analysis of Flow and Cavitation Phenomena in Diesel Injection Nozzles and its Effects on Spray and Mixture Formation", M. Blessing, G. König, C. Krüger, U. Michels and V. Schwarz, SAE Technical Paper 2003-01-1358, (2003).



Ballistic imaging

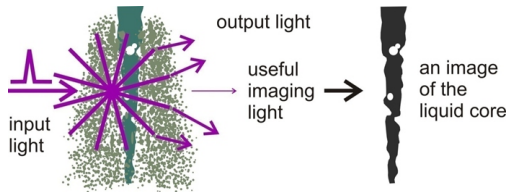

- ▶ This technique was originally developed in 2000 by the Linne group¹³ based on a medical imaging technique that did not work (for tissue).
- ▶ Use what we know about light traversing a turbid medium:
 - ▷ Most of it is just spatial noise that corrupts the image because it was scattered off-axis by drops
 - ▷ A very small amount of it contains useful image information about structures (e.g. intact liquid) buried inside - it was refracted by the larger structures.
- ▶ We minimize the amount of corrupted light and collect as much useful imaging light as possible.

¹³ "Imaging in the Optically Dense Regions of a Spray: A Review of Developing Techniques", M. Linne, Progress in Energy and Combustion Science, Vol. 39, No. 5, 403 - 440, (2013).



Ballistic imaging

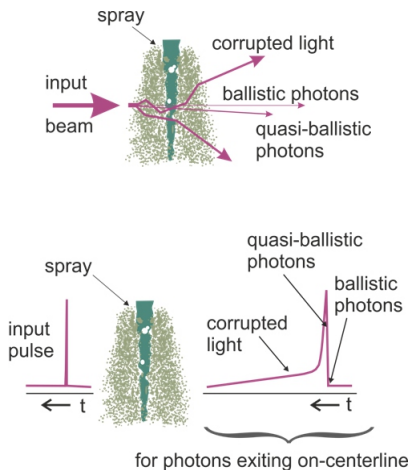

- ▶ Even in turbid media, some photons do not scatter, passing directly through the medium - called ballistic photons. Photons scattered into the droplets forward lobe (quasi-ballistic) can behave almost exactly the same way - all of them together are called useful imaging light.
- ▶ Because they do not scatter at significant angles, useful imaging photons have the shortest path length and exit first.



Ballistic imaging

- ▶ Useful imaging photons can be used to image the liquid core - if one can sufficiently minimize the contribution of the much more prevalent corrupted light.
- ▶ This can be done by emphasizing signatures of the useful imaging light:
 - ▷ Directional orientation - useful light is coincident with the input beam (some form of spatial filtering)
 - ▷ Preservation of polarization (polarization filtering)
 - ▷ First to exit (time gating)
 - ▷ Ballistic photons themselves are coherent with the input beam (coherence gating - interferometry, DFWM), but coherence is not used for sprays because only the ballistic photons are coherent and too many of them are lost in a very dense spray.



Ballistic imaging

Typical BI system

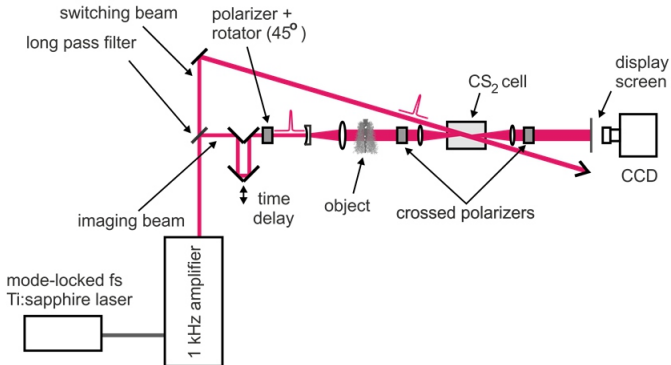

Ballistic imaging

Typical BI system

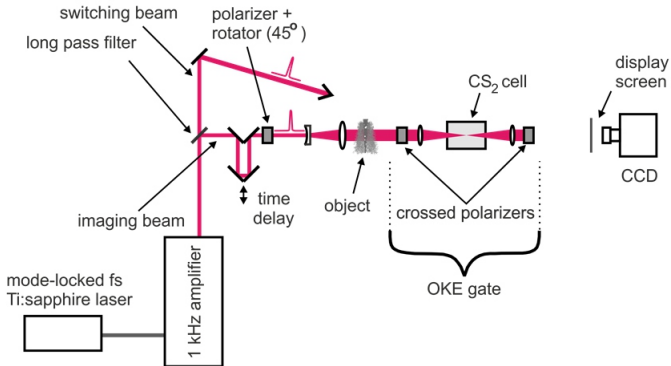

Ballistic imaging

Typical BI system

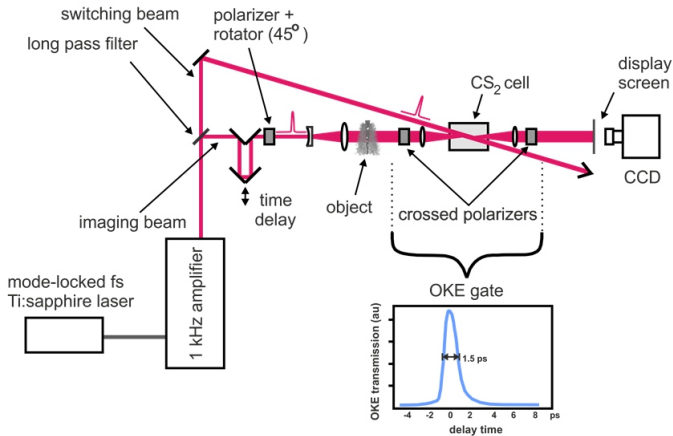

Ballistic imaging

Diesel sprays by 2 different groups

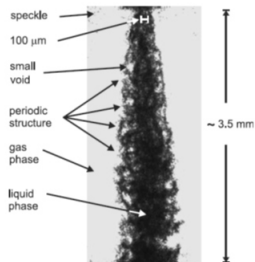

CSM[§], Diesel fuel spray into 1 atm at $We = 7.6 \times 10^5$ & $Re = 1.6 \times 10^4$



CNRS/CORIA[‡]
steady period



late in injection



CNRS - UNIVERSITE et INSA de Rouen

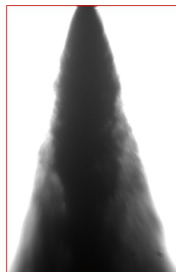

shadowgram of spray

[§] M. Linne, M. Paciaroni, T. Hall, and T. Parker, Experiments in Fluids, 40, 836-846, (2006).

[‡] S. Idlahcen, J.-B. Blaisot, T. Girasole, C. Rozé and L. Méès, 14th Int Symp on Applications of Laser Techniques to Fluid Mechanics Lisbon, Portugal, 07-10 July, (2008).



Ballistic imaging

An aerated (“effervescent”) jet

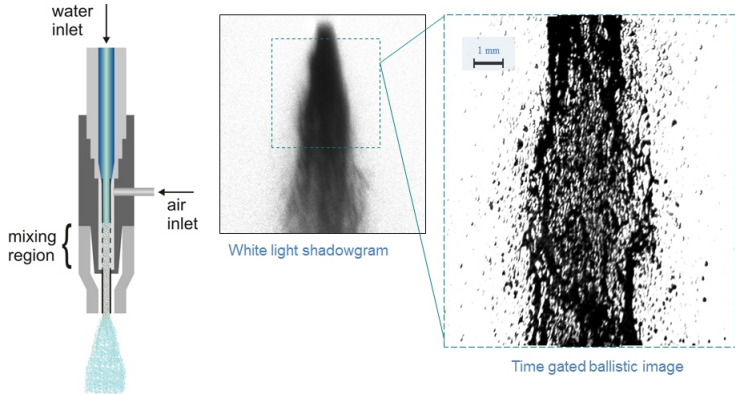

Multi-pulse BI

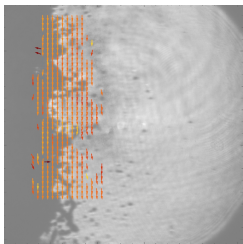
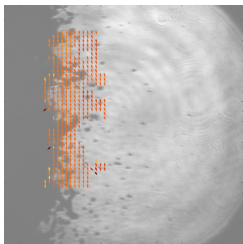

- ▶ Two BI taken in rapid succession (e.g. $\Delta t = 10\mu s$) can be analyzed as discussed in Lecture 12 to extract velocities of the liquid/gas interface, of ligaments, or of large refractive drops.
- ▶ This one is taken from a steady water jet undergoing turbulent primary breakup, with the edge of the jet magnified.
- ▶ With a three-pulse system, it is possible to get a second velocity image.



Multi-pulse BI¹⁴

- ▶ Two velocity images can be subtracted to extract acceleration (for known image time separation). High acceleration to low: yellow-to-orange-to-red, orange is $\sim 5m/s^2$.
- ▶ Because densities are constant, these are images of the forces acting on the fluid features.

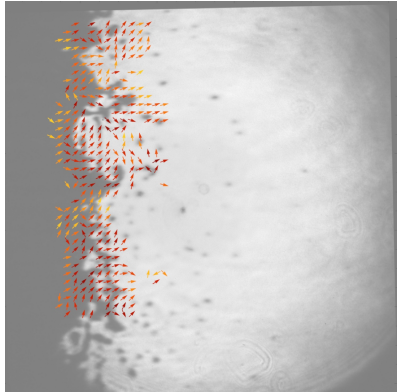

¹⁴ "Visualization of acceleration in multiphase fluid interactions",
D. Sedarsky, M. Rahm, and M. Linne,
Optics Letters, Vol. 41, No. 7, 1404-1407, (2016).

Ballistic imaging

Attributes of BI

- ▶ Meant only for very dense sprays.
- ▶ A line-of-sight technique, but it captures the liquid/gas interface with good spatial resolution (from 20 to 30 μm ; FWHM of the PSF).
- ▶ Images all refractive structures, but it's not a drop sizing technique.
- ▶ Can go up to $OD = 14$.
- ▶ Can extract statistics on:
 - Ligament size distributions
 - Surface curvature distributions
 - Interface velocity
 - Void size distributions
 - Surface wave spectra
 - Interface acceleration

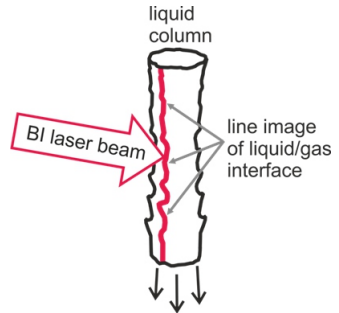

Ballistic imaging

Study if transitional jets

- ▶ Under supercritical conditions:
 - ▷ The critical points (P_c and T_c) for a mixture of substances can be quite different from the critical points for each of the constituents of the mixture in their pure form,
 - ▷ Surface tension ~ 0 ; evaporation from an interface is replaced by diffusive mixing across a thickened layer,
 - ▷ The solubility of materials into the fluid grows,
 - ▷ Thermal conductivity and mass diffusivity can vary much more strongly,
 - ▷ The latent heat of vaporization goes almost to zero owing to the practical absence of surface tension,
 - ▷ Heat capacity shoots up at the critical point and then falls back downwards,
 - ▷ Viscosity grows past the critical point, and
 - ▷ The speed of sound trends downwards to about 50% of the subcritical value as conditions approach supercritical, and then it can rise steeply once a supercritical state is reached.



Ballistic imaging

Study if transitional jets

- ▶ The question of whether or not Diesel jets transition to a supercritical state has been investigated with BI¹⁵.
- ▶ Three pure fuels were studied:

Fuel	$T_{bp}(K)$	$T_c(K)$	$P_c(MPa)$
Butanol	391	562	4.5
n-dodecane	489	658	1.8
n-hexadecane	554	722	1.4

together with commercial Diesel fuel.

- ▶ At three different conditions in a spray chamber:

Case	$T(K)$	$P(MPa)$
1	450	3.0
2	675	4.5
3	900	9.0



Ballistic imaging

- ▶ Laser shadowgraphy (for the outer part of the spray) and BI (for the core region) were used simultaneously.

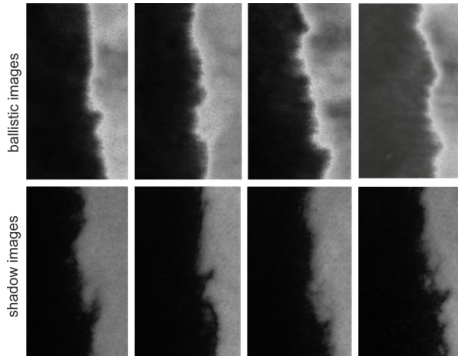

- ▶ Magnified images of the edge of the jet.
- ▶ Results for Diesel fuel under Case 1, well below the critical point.
- ▶ The BI have a distinct liquid/gas interface and the shadow images have drop clouds. This is a normal spray.



Ballistic imaging

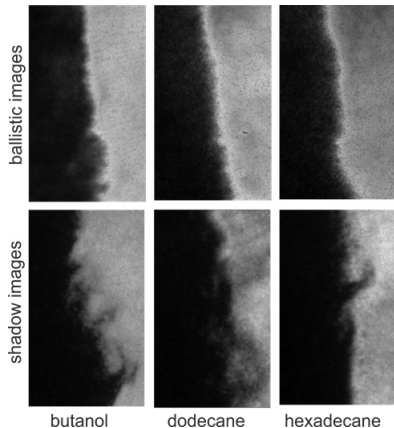

- ▶ Results for 3 fuels under Case 1, well below the critical point.
- ▶ The BI have a distinct liquid/gas interface and the shadow images have drop clouds. These are normal sprays.



Ballistic imaging

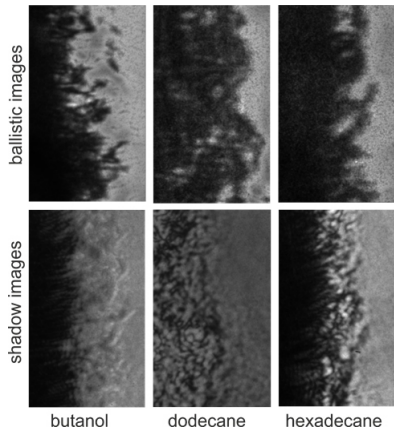

- ▶ Results for 3 fuels under Case 3, above the critical point.
- ▶ The Butanol BI shows an edge that has become miscible in the background fluid, dodecane is growing thin but maintains an interface, and hexadecane has ligaments - maintains surface tension.



Ballistic imaging

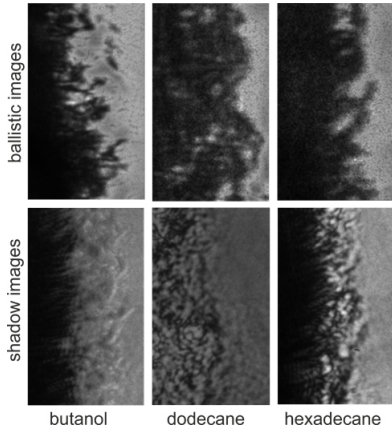

- ▶ Consider the image differences between shadowgraphy and BI.



Ballistic imaging

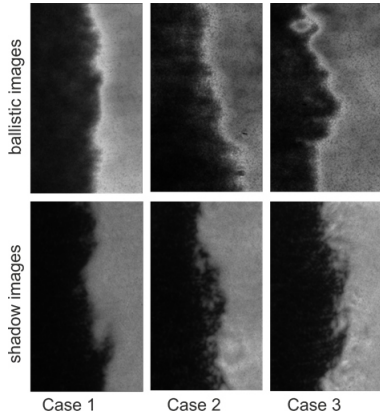

- ▶ It seems that commercial Diesel fuel does not respond strongly.



Optical sectioning

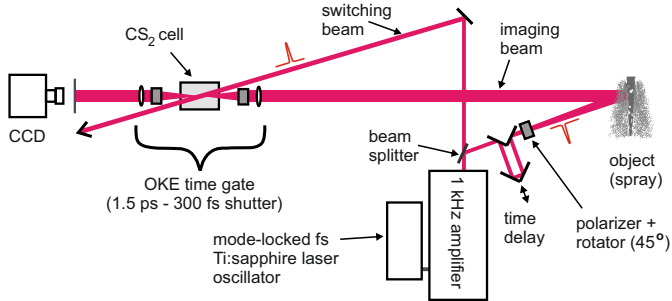

- ▶ This is a brand new technique under development in the Linne group, based on ideas from biological microscopy.
- ▶ Here backscattered light from the laser is time gated and imaged. The signal is weaker because the backward scattering lobe is much weaker, and a diffuse source of light must be collected and imaged.
- ▶ The technique does work when using a low light level detector.



Optical sectioning

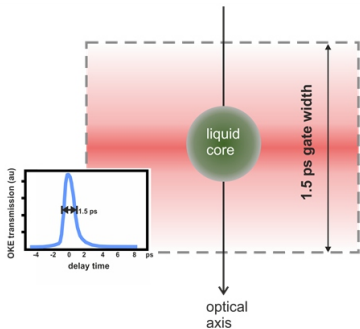

- ▶ The gate time corresponds to a slice of light in space (1.5 ps is equivalent to $\sim 450\mu m$ in depth along the optical axis), i.e. the spatial resolution along the optical axis is given by the OKE gate opening time.
- ▶ By changing the time delay between the gate and the backscattered image pulse, it is possible to walk the sampled plane through an object.
- ▶ That explains the name of the technique.



Optical sectioning

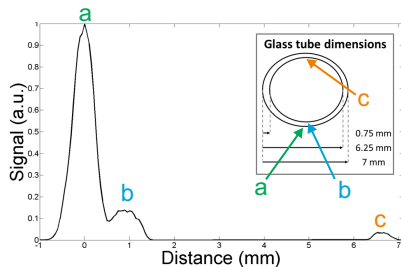

- ▶ Here a glass tube was placed at the centerline of a Diesel injector we were studying.
- ▶ By changing the time delay it was possible to scan from the input face of the tube (**a** in the image), to the inside of that same face (**b**) and to the other inside (**c**). The signal from the back on the outside was too weak.
- ▶ The distances in the image are extracted from time delay and they are correct.



Optical sectioning

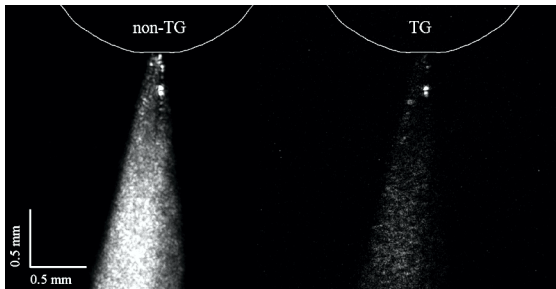

- ▶ Here are non-time-gated (“non-TG”) and time-gated (“TG”) backscattered images from a Diesel spray.
- ▶ The non-TG image comes mostly from the conical surface of the spray while the TG is from a plane inside.
- ▶ We have scanned the OKE gate delay time, and have been able to scan from the front to the back of the spray.



Optical sectioning

- ▶ Thus is a brand new concept we have just demonstrated.
- ▶ Unfortunately the drop images are dominated by glare spots, and even bigger structures have them.
- ▶ It may be possible to make the drops opaque so that they do not transmit the light.



PIVOTS

Backscatter Particle Image Velocimetry via Optical Time-of-Flight Sectioning¹⁶

- ▶ This technique is multi-pulse OS with correlation velocimetry.
- ▶ It requires only one access port.
- ▶ Time gate eliminates signal from outside the effective imaging plane.
- ▶ They looked into a test cell with a slow (because they had just one 1-kHz system), particle laden jet → videos.

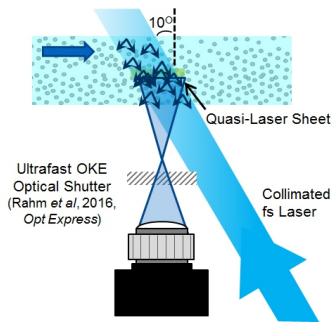

¹⁶ "Backscatter Particle Image Velocimetry via Optical Time-of-Flight Sectioning (PIVOTS)", M. E. Paciaroni, Y. Chen, K. Lynch, and D. R. Guildenbecher, in preparation for submission to Optics Letters, (2017).

Next topic

X-ray imaging



THE UNIVERSITY of EDINBURGH
School of Engineering